

OCR (J276) GCSE

COMPUTING

Knowledge Organisers

```
for i in knowledge_organiser :  
    long_term_memory.append[i]
```

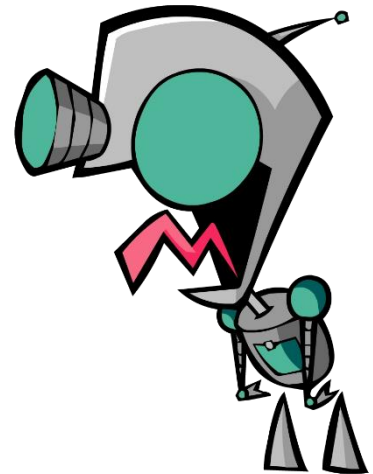

Computing GCSE – 1.1

J276/01 – Systems Architecture a

KEY VOCABULARY

CPU	<i>Central Processing Unit.</i> - The “brain” of the computer
CU	<i>Control Unit.</i> - Part of the CPU that manages the functions of all other parts of the CPU
Decoder	Part of the CU which decodes the binary instructions fetched from memory
RAM	<i>Random Access Memory</i> - The main volatile memory into which programs are loaded from the hard drive
MAR	<i>Memory Address Register</i> - Small fast memory used to store the RAM address of the next instruction
MDR	<i>Memory Data Register</i> - Small, fast memory used to store the information collected from the RAM before processing
PC	<i>Program Counter</i> - Keeps track of the current instruction number of the program
Accumulator	Small, fast memory, used to keep track of the data currently being processed
ALU	<i>Arithmetic and Logic Unit</i> - Does the basic mathematics and comparisons during processing
Bus	A physical connection between two elements of a computer system that allows the transfer of data.
Cache	Incredibly fast, but very expensive volatile memory using in the CPU
Bridge (North / South)	Junctions on a motherboard where the bus connections are controlled and routed. Northbridge deals with core functions, whilst the Southbridge deals with the peripherals, input and output devices and Secondary Storage.
von Neumann Architecture	The method used by all modern computers to allow the programming of a machine to be changed depending on the required function.
Fetch / Decode / Execute Cycle	Basis of the von Neumann architecture – the repeated process where instructions are fetched from RAM, decoded into tasks and data, then carried out.
Clock Speed	The number of FDE cycles that a CPU can carry out per second. Measured in Ghz (1 Ghz = 10^9 cycles per second or 1,000,000,000hz)
Cores	Some processors have multiple CPUs which can work in parallel, sequentially or can multitask. Dual and Quad cores are common in modern PCs

An example of a typical PC’s innards.

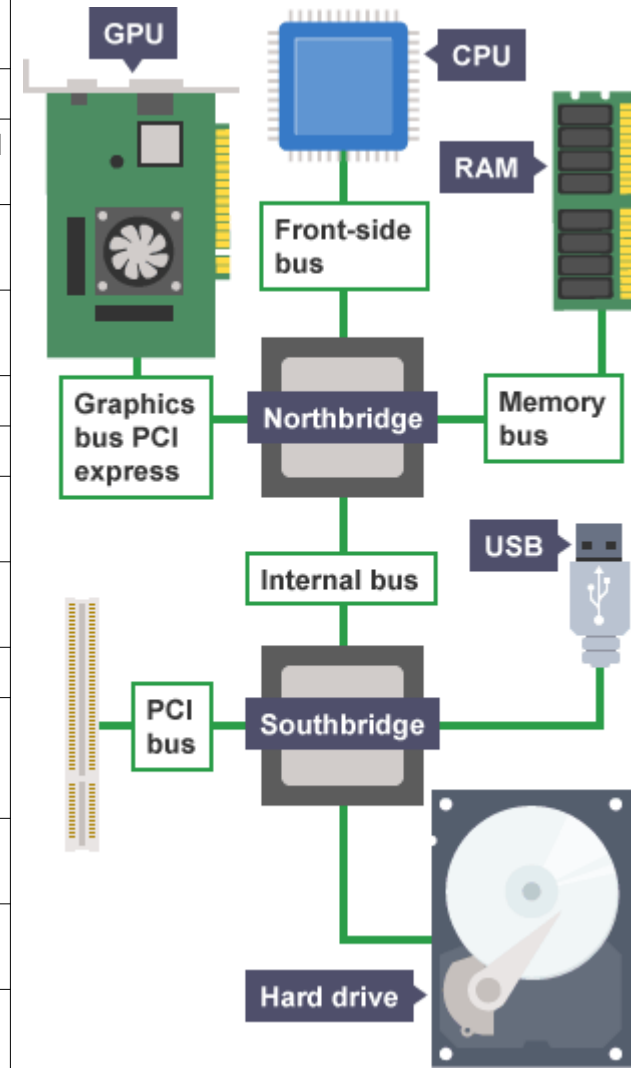

Computing GCSE – 1.1

J276/01 – Systems Architecture b

BASIC DIAGRAM OF CPU

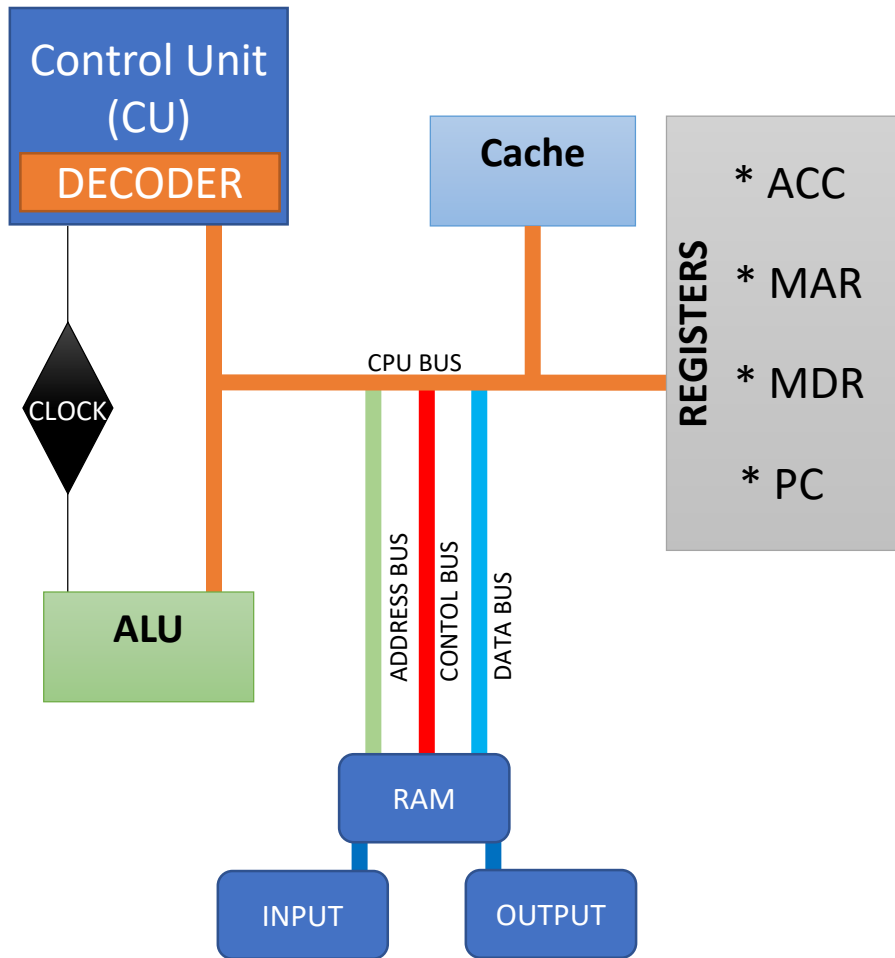

The FETCH – DECODE – EXECUTE cycle

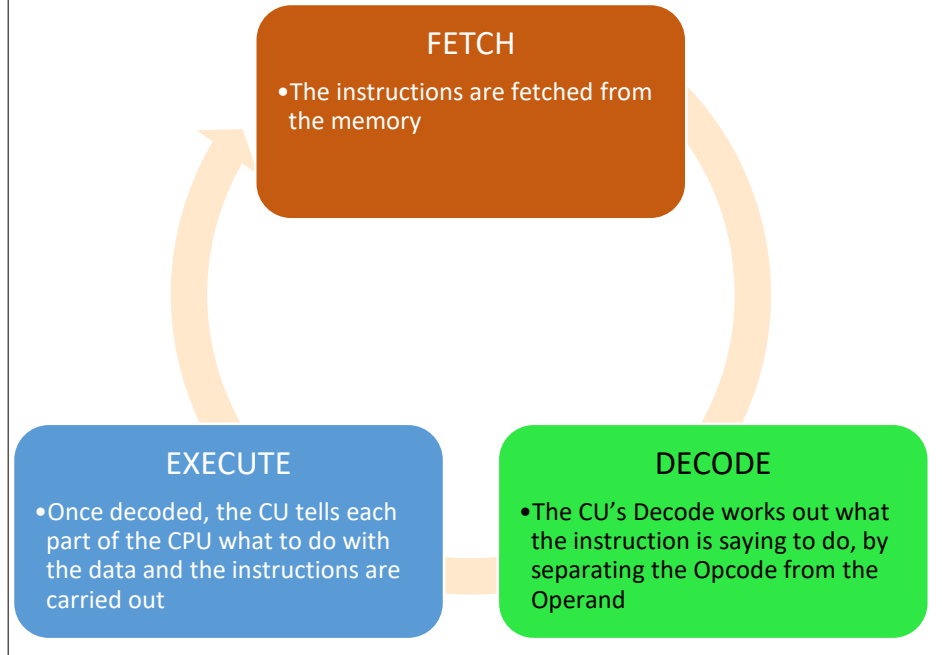

KEY VOCABULARY

Machine Code	A program, stored in binary, that the CPU undertakes the FDE cycle on. All programs must be in machine code to work
Instruction	A single line of machine code, containing the command and data location on which it is to be executed. Stored in binary
Opcode	The first part of the instruction, is the command
Operand	The second part of the instruction is the data on which to carry out the command. This may be actual data stored in binary form, or a memory location reference of where to find the data

Multi Core Processing

Some processors have multiple CPU cores on one chip. They all have their own Level 1 cache, but share Level 2 cache, allowing them to collaborate quickly on large tasks.

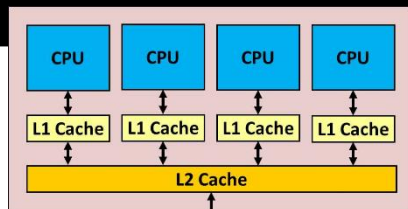

Computing GCSE – 1.1

J276/01 – Systems Architecture – CPU and Fetch/Decode/Execute Cycle

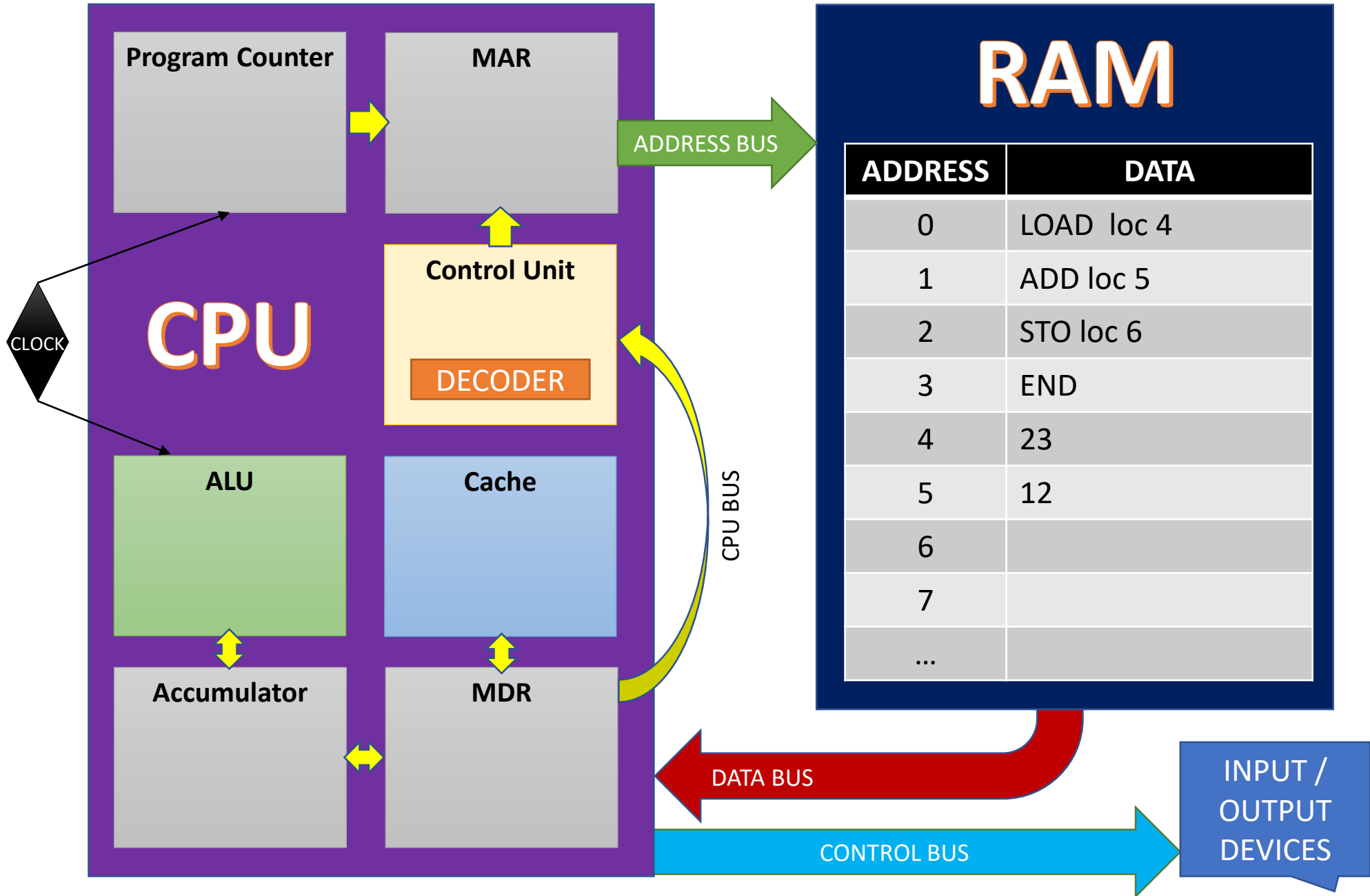

Computing GCSE – 1.1

J276/01 - Memory

KEY VOCABULARY

Volatile	Memory which requires constant electrical charge. If the power is turned off, then the data is lost
Non-volatile	Memory which can retain its data when the power is turned off
RAM	<i>Random Access Memory</i>
ROM	<i>Read-Only Memory</i>
Cache	Very fast memory, on, or very close to the CPU
Virtual Memory	A section of the HDD which can be used as RAM for very memory intensive processes
Flash Memory	A type of dynamic (changeable) ROM
Boot Process	The instructions needed to start the computer and to initialize the operating system.
POST	<i>Power On Startup Test</i> A series of checks done on the hardware of the computer to ensure the machine can run.

PRIMARY MEMORY

TYPE	VOLATILE?	DYNAMIC?	RELATIVE SPEED
Cache	YES	YES	Very Fast
RAM	YES	YES	Fast
ROM	NO	NO	Slow
Flash	NO	YES	Slow
Virtual	YES	YES	Very Slow

PRIMARY STORAGE - MEMORY

RAM is *volatile* memory, which stores data in a single transistor and capacitor. This means it needs a constantly recycled charge to hold its data. If the power is turned off, it cannot refresh the data and it is lost. This is known as *DYNAMIC* memory. The computer uses RAM to store the current program or data being used.

ROM is non-volatile. The data is hardcoded onto the chip by the manufacturer, and cannot be overwritten by the user. Because it holds its information even when the power is turned off, this makes ROM ideal for storing the instructions needed to get the computer started up – the *BOOT PROCESS*, and *POST*.

Flash Memory is a new(ish) type of ROM chip which holds its data when there is no power making it *non-volatile* but that can be rewritten easily by the user. By using a relatively large electric current, electrons can be *forced* through a barrier and into the *storage layer*. The pattern of electrons can be read as data without affecting the data.

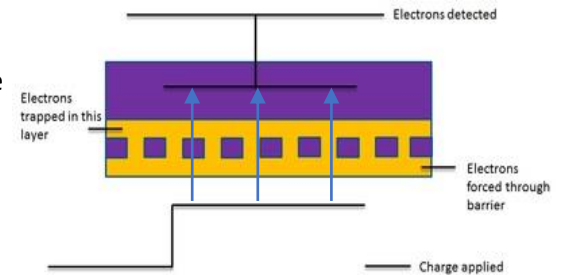

VIRTUAL MEMORY

To increase the speed and efficiency of RAM, most machines allocate a small portion of the Hard Disk to *VIRTUAL MEMORY*. The contents of the RAM are moved between the slower Virtual Memory and RAM as and when they are needed.

Using / Increasing Virtual Memory does not improve the speed of the computer, but rather using Virtual Memory increases the threshold at which a computer locks, by increasing the usable memory, and preventing deadlock due to filling the available primary memory.

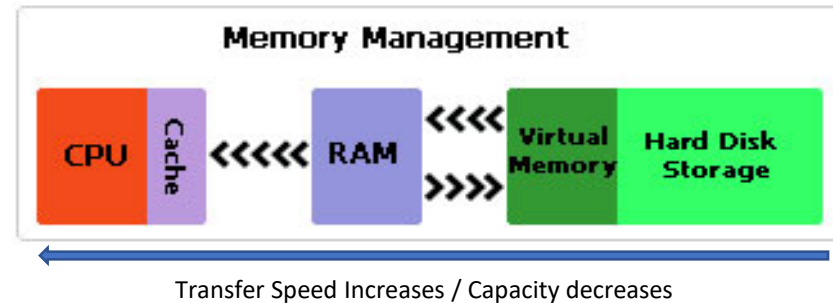

Computing GCSE – 1.3

J276/01 – Storage

All basic computing functions are done using Primary Storage – but this is either *volatile RAM* or *static ROM*. To allow storage of a user’s information once the power is turned off, *non-volatile, secondary storage* is required.

KEY VOCABULARY

Secondary Storage	Primary storage is RAM. Secondary storage refers to long term, non-volatile data storage.
Non-volatile	Memory which can retain its data when the power is turned off
Magnetic	Data is stored by altering the magnetic charge (+ or -) to represent binary information
Optical	A reflective layer or dye is marked to either reflect or not reflect a laser beam. The computer reads the reflections as binary data
Solid State	Also known as <i>Flash Memory</i> , the data is stored by forcing (or flashing) electrons through a barrier into a storage layer. Here it is read as binary information

SECONDARY STORAGE

TYPE	CAPACITY	COST	SPEED	Pros	Cons
Magnetic	Very High	Low	Fast	Cheap and readily available. Can have very high storage capacity and is reliable	Slow read and write speeds. Moving parts make it susceptible to damage if moved. Data can be wiped if placed near a magnet
Optical	Low	Very Low	Slow	Cheap. Can be either Read or Read/Write.	Requires an optical drive to be read. Data corruption occurs over time (10+ yrs)
Flash / Solid State	Low	High	Very Fast	Much faster than magnetic drives. No moving parts, so hard to damage by movement. Silent.	Expensive and relatively low capacity. Has limited usable life – about 100,000 rewrites.

EXAMPLE FILE SIZES

1 page text	100kb
1 photo	6mb
3 min MP3	6mb
3 min audio track (CD)	50mb
DVD film	4gb
HD film	8-15gb
Blu-Ray film	20-25gb
4k film	100gb +

SECONDARY STORAGE SPECS

TYPE	CAPACITY	SPEED
Magnetic HDD	Terabytes	50-120 MB/s
CD	700 mb	0.146 MB/s
DVD	4.7 gb	1.32 MB/s
Blu-Ray	128 gb	72 MB/s
SD Cards	4-32 gb	50-120 MB/s
USB Drive	Up to 1 tb	45-90 MB/s
Solid State Drive (SSD)	Up to 4 tb but <i>very expensive</i>	200-550 MB/s

CONSIDERATIONS WHEN SELECTING SECONDARY STORAGE

Capacity	How much data will it need to hold?
Speed	How quickly must the data be written / read?
Portability	Does the storage device need to be transported? If yes, then size, shape and weight are important. Will it require other devices to be used (eg. An optical reader).
Durability	How <i>robust</i> is the device? Can it be moved without fear of damage? Will it be used in a difficult environment? Does it need to be single use or rewritable?
Reliability	Does it need to be used over and over again without failing, or will it receive minimal reuse? Will it need to store the information for long periods of time?
Cost	Needs to be compared with the above and considered.

Computing GCSE – 1.4a

J276/01 – Wired and Wireless Networks

KEY VOCABULARY

Stand Alone	A single machine, not connected to another
Network	A collection of machines which can communicate with one another
Transparent	The end-user has no need to know the specifics of a network's infrastructure
Node	A device on a network (PC or other device)
Link	The connections between nodes
LAN	Local Area Network (Single location)
WAN	Wide Area Network (Multiple connected locations)
VPN	Virtual Private Network
UTP	Unshielded Twisted Pair – a type of cable
Client	The user machines on a network
Server	The central 'controller' machine on a network, including main data storage
P2P	Peer-2-Peer. A network without a server.
WAP	Wireless Access Point
NIC	Network Interface Controller
Router	Controls the sending of data around a network
Hub	A central connection for a small network, which broadcasts all data to all clients
Switch	A smart hub for larger networks which only sends the data to the intended client
Internet	A worldwide collection of networks
WAP	Wireless Access Point

WHY NETWORK?

There are many reasons to create networks of computers, and increasingly few reasons not to.

Positives

- Communication between users
- Sharing of files
- Sharing of peripheral devices
- Monitoring user activity
- Access control or other security features
- Centralised administration of machines
- Multiple work stations available for users
- Possible to distribute workload for large tasks

Negatives

- Higher cost than single machines
- Requires additional hardware
- Requires administration
- Open to attacks
- Client-Server systems are vulnerable to server failure

NETWORK HARDWARE

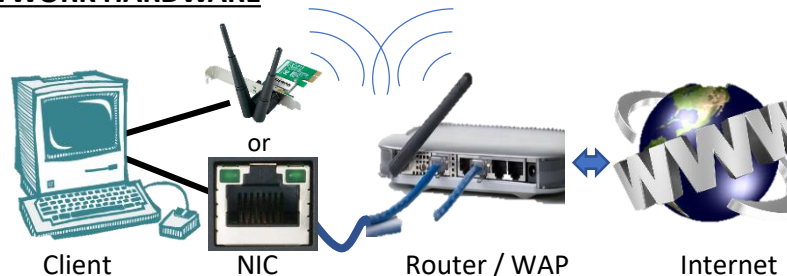

All clients need an NIC to connect to a ROUTER. This could be a wireless adapter or a network card. The Router in this simple connection can host multiple clients, but more advanced hardware is needed for bigger networks

NETWORK ORGANISATION

CLIENT - SERVER

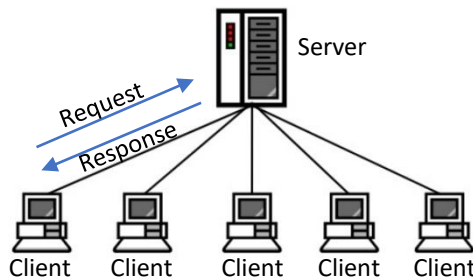

A single high-spec machine is designated the server, which includes the main file storage. Each client then *requests* data from the server which *responds* and fulfills the request.

PEER TO PEER

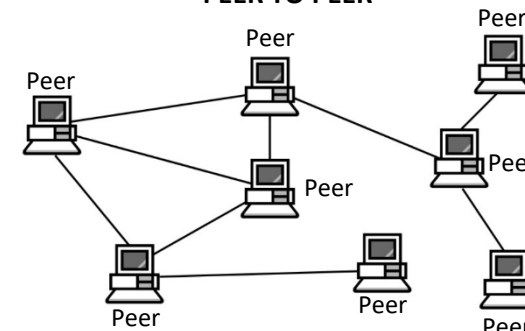

A *distributed* system where each node is equal. Every computer can serve and request data from all others. The system is easy to set up, but slow and difficult to administer.

Computing GCSE – 1.4b

J276/01 – The Internet

KEY VOCABULARY

WAN	Wide Area Network
VPN	Virtual Private Network
Client	The user machines on a network
Server	The central 'controller' machine on a network, including main data storage
Internet	A worldwide network of networks
DNS	Domain Name Server
Hosting	Storing a file on a web-server for access via the internet
Cloud	A service which is stored remotely
TCP/IP	Transmission Control Protocol / Internet Protocol. These are the standards that allows network nodes to communicate with one another on the internet
WWW	World Wide Web - Pages of content
email	Electronic mail, sent through the internet
URL	Unique Resource Location

Virtual Private Networks

VPNs are small collections of devices that act as though physically connected in a LAN, but are actually widely distributed and use the internet as their network connections.

VPNs allow users to store data in a small, private area of the internet, so they can get to it at any time, using an internet connected device.

The benefits are low cost and widely available data, but users must ensure that the data is protected as, without security, their data is available to anyone connected to the internet!

How DNS works

All webpage has an **IP Address** which is a unique reference to find that page. But 87.245.200.153 isn't as easy for users to remember as google.com

When the user types google.com into a web browser's address bar, the client sends a request to the DNS for the current location of google.com. The DNS returns the request, telling the browser to go to 87.245.200.153. The browser now connects to the google server, at the IP address given, and looks for the index.html file to start displaying the webpage.

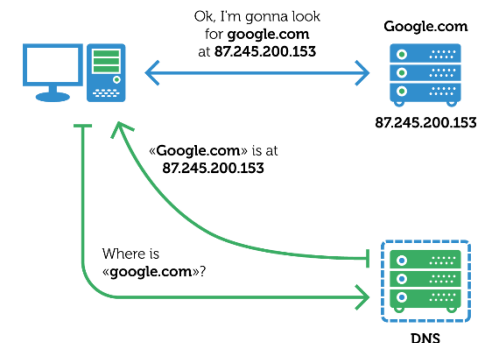

DNS Hierarchy

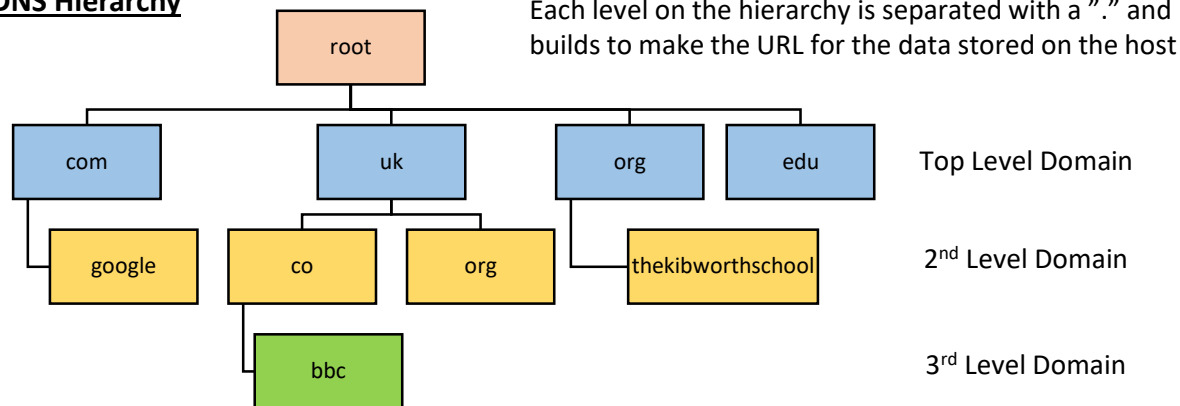

The Cloud

As our devices are all connected to the internet, they start to become client nodes in a web connected "cloud" network. It's called cloud because your data, services and applications are available everywhere without wires. It's just 'there' – like a cloud. PCs like the Google Chromebook utilise the cloud to provide very cheap, very fast hardware, which just connects you to the internet. All the storage, applications and communication is done by services hosted on google's servers.

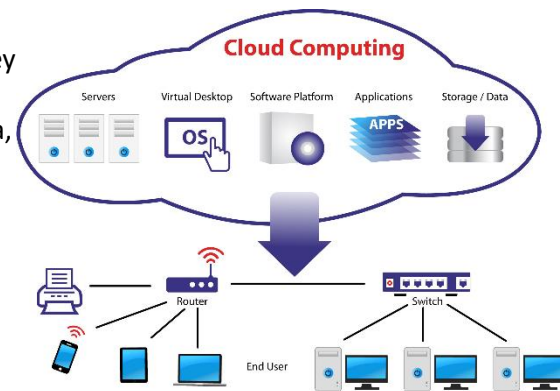

Computing GCSE – 1.5a

J276/01 – Network Topology

Topology means “how a network is laid out and the connections between computers”

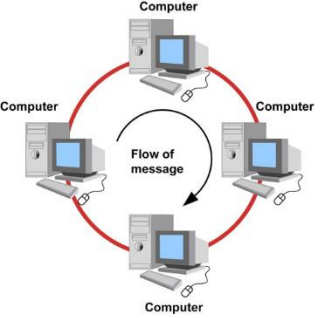
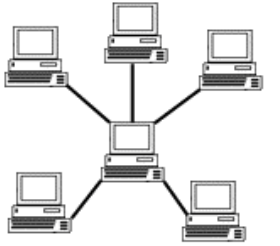
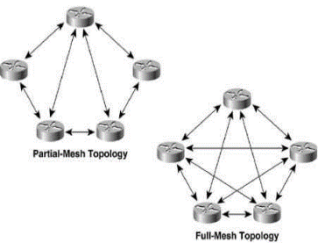
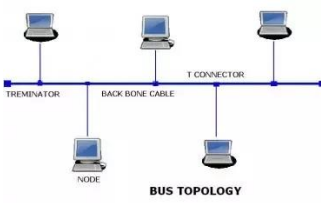
NAME	DIAGRAM	DESCRIPTION	ADVANTAGES	DISADVANTAGES
Ring		<p>Each node is connected to 2 others, and packets tend to travel in 1 direction.</p>	<p>All data flow in 1 direction – greatly reduced chance of collisions.</p> <p>No need for network server</p> <p>High speed</p> <p>Additional nodes can be added without affecting performance</p>	<p>All data passes through every workstation on route</p> <p>If 1 node shuts down, then network collapses</p> <p>Hardware is more expensive than switches / NICs</p>
Star		<p>Each node connects to a hub or switch. A central machine acts as server whilst the outer nodes are clients.</p>	<p>Centralised management through the server</p> <p>Easy to add more machines to the network</p> <p>If 1 machine fails, the others are unaffected</p>	<p>Potentially higher set up costs, especially in server and switch set ups.</p> <p>Central server determines the speed of the network and the number of possible nodes</p> <p>If the server fails then the network fails</p>
Mesh		<p>Every nodes is interconnected with every other, allowing for distributed transmission.</p> <p>Mesh topology can be FULL MESH (where every possible connection is made) or PARTIAL MESH (at least 2 computers are connected with multiple links)</p>	<p>Multiple devices can transmit data at once, therefore can handle large amounts of data</p> <p>A failure of 1 device does not affect the rest of the network</p> <p>Adding devices does not impact on data transmission between existing devices</p>	<p>Cost is higher due to increased hardware requirements</p> <p>Building and maintaining a mesh network is costly and time consuming</p> <p>The chance of redundant connections is very high, which increases the cost, and makes the network cost inefficient</p>
Bus		<p>Bus or Line topology is a network where all nodes are connected to a single cable (backbone).</p>	<p>Works well with small networks</p> <p>Easiest option for connecting nodes with shared peripherals</p> <p>Least costly in terms of hardware and cabling</p>	<p>Difficult to fault test because who network crashes when there are errors</p> <p>Additional devices slow down the network</p>

Computing GCSE – 1.5b

J276/01 – Network Protocols

KEY VOCABULARY

Protocol	The rules and standards that are agreed in order to make it possible for different devices to talk to one another	
IP Address	Each node on a network is given a unique 32 bit address (4x8bits) for example 192.168.0.1 There are 4 billion possible combinations.	
DHCP	Dynamic Host Configuration Protocol – this protocol allows the network server to control the allocation of IP addresses	
MAC Address	Media Access Control Unique addresses hard-coded into the network interface controller. Gives the manufacturer, NIC type and unique identifying number. 48 bits displayed as Hex (eg 01-23-45-67-89-ab-cd-ef)	
TCP/IP	Transmission Control Protocol / Internet Protocol	A set of protocols that governs the transfer of data over a network
HTTP	Hyper Text Transfer Protocol	Standards for writing webpages to display content for display
HTTPS	<i>Hyper Text Transfer Protocol Secure</i>	<i>Client-server protocol for requesting (client) and delivering (server) resources, such as HTML, securely</i>
FTP	<i>File Transfer Protocol</i>	<i>Used to directly send files from one node to another over the internet. Commonly used for uploading files to web servers</i>
POP	Post Office Protocol	Used by email clients to download email from the remote email server and save it onto the users computer. More or less redundant now, and has been replaced by IMAP
IMAP	Internet Message Access Protocol	An alternative to POP, allowing more control such as the complete control of remote mailboxes
SMTP	Simple Mail Transfer Protocol	An old standard for transmission of email. SMTP can only be used to <i>push</i> mail to client machines, whilst both POP and IMAP are used by clients to <i>retrieve</i> mail.

ENCRYPTION

Encryption is taking a message and changing the letters in such a way that it is not readable. The correct recipient knows how to unscramble the message and can read the text.

Modern encryption is 128bit and secure against brute force attacks

PUBLIC KEY ENCRYPTION

Public Key Encryption is a method of securely sending data over the internet. The recipient's computer uses an algorithm to produce 2 linked keys: a public key and a private key.

1. Alice (the sender) requests Bob's (the recipient) public key. This is shared.
2. Alice uses Bob's public key to *encrypt* the message she wishes to send
3. The encrypted document is sent over the internet – it is secure.
4. When Bob receives the encrypted document he combines his public key with the secret private key. This allows the message to be decrypted and turned back into plain text

Asymmetric Encryption

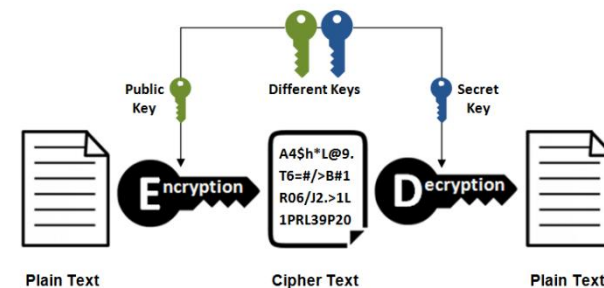

Computing GCSE – 1.5c

J276/01 – Network Layering

KEY VOCABULARY

Protocol	The rules and standards that are agreed in order to make it possible for different devices to talk to one another
Layering	Rules organised into a distinct order in which they need to be applied
Interoperability	The ability for different systems and software to communicate, exchange data and use the information exchanged
Encapsulation	Enclosing data inside another data structure to form a single component
De-encapsulation	Removing data from inside and encapsulated item.

WHY LAYER?

Layering allows problems to be broken down into small chunks, and then smaller solutions created to specific parts of the problem. These small parts interact in an agreed manner, allowing the solution to be built by different teams or companies.

Layering is not unique to computing. In the car industry, a Ford engine might be used with a Jaguar gearbox in a Mazda car. By separating these 'layers', but agreeing on the interface between the layers, each company is free to develop their layer as they see fit, without affecting the other layers. It is also possible to swap one layer out, and replace it with another one – such as swapping an engine for a more powerful one.

This *interoperability* is important as it allows data (in computing) to be passed from one layer to the next.

TCP/IP Protocol Layers

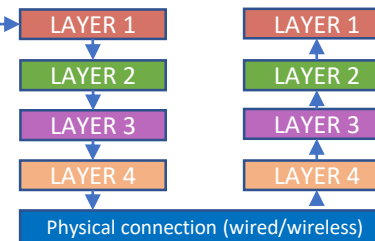
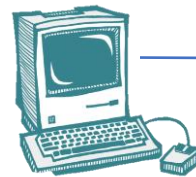
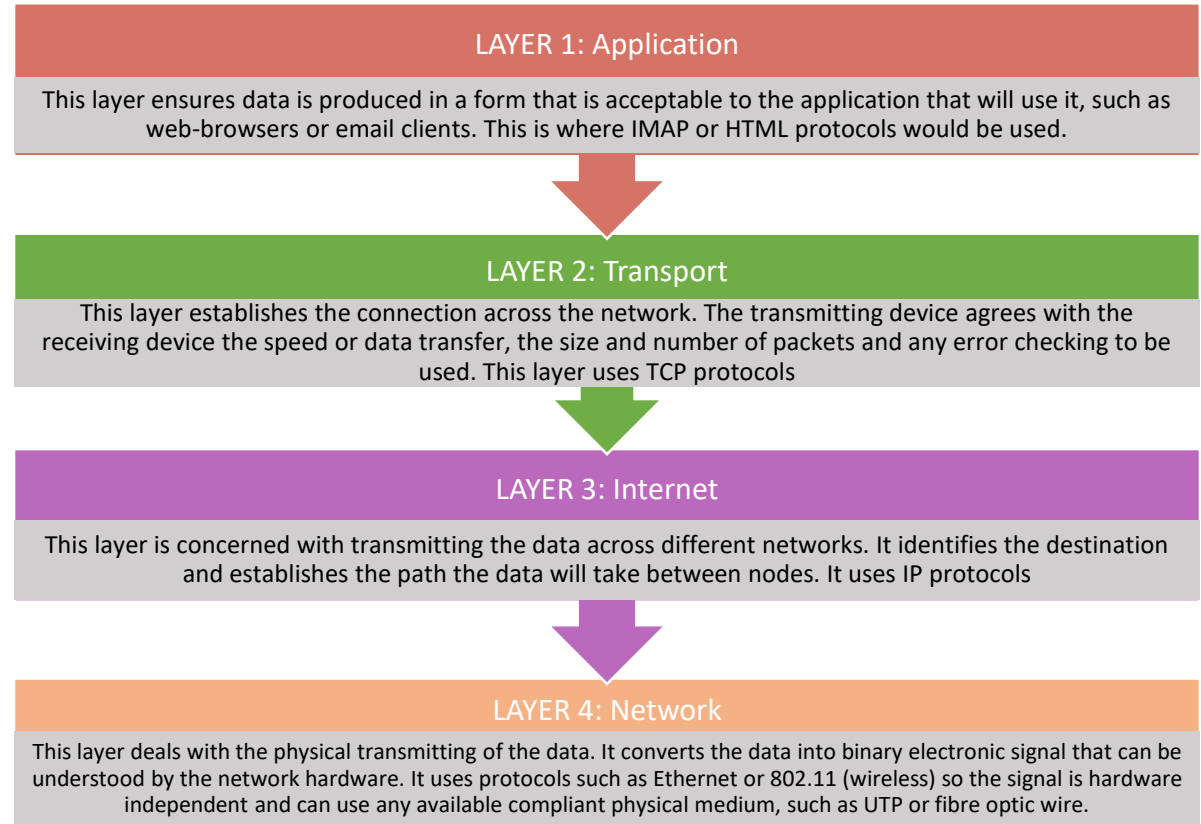

Data transfer occurs by breaking the file into small *packets*, adding each layer to the packet in order at the sending device, then decoding in reverse order at the receiving device before rebuilding the file.

Packet switching is the process that modern networks use to send large data between devices. The data is split into small *packets* and numbered. The packets can travel by any route to the destination where the receiving machine reassembles them into the correct order.

Computing GCSE – 1.6a

J276/01 – System Security

KEY VOCABULARY - VULNERABILITIES

Hacking	Attempting to bypass a system's security features to gain unauthorised access to a computer
Malware	Malware is malicious software, loaded onto a computer with the intention to cause damage or to steal information. Viruses are a type of malware
Phishing	Phishing is a common way to try to steal information like passwords. Emails are sent, requesting the user logs into a website, but the site is a fake, and the users details are logged
Social engineering	People are the weakest point of any system. If a hacker can convince a user to give over their data, this is the easiest way into a secure system
Brute force attack	Using an algorithm to try every possible combination of characters to 'guess' the users password.
Data interception	Data interception, or <i>Man in the Middle attacks</i> are hacks that use 'packet sniffer' software to look at every piece of data being transmitted in the local area to find ones that meet the hacker's criteria. Often done by creating 'fake' wireless networks to record users details
SQL injection	Using SQL statements to trick a database management system (DBMS) into providing large amounts of data to the hacker
Denial of Service Attack	Hackers flood a network with huge amounts of fake data and requests in an attempt to overload the system so that it crashes

KEY VOCABULARY - PROTECTIONS

Penetration Testing	Employing a <i>white hat hacker</i> to try to break into a system to test how good the security is. Any problems in the security can then be fixed before they become vulnerable to real attack
Network forensics	Network procedures that capture, record and analyse all network events to discover the source of security attacks
Network Policies	Rules which govern how a network may be used – see over page
Anti-malware software	Software which analyses files, network traffic and incoming data to look for known malware such as viruses or worms. An infected file is quarantined, and either cleaned or securely deleted to prevent further infection. Needs updating very regularly to ensure that the newest malware is being checked for
Firewall	A firewall protects a system by checking all incoming and outgoing network traffic is legitimate
User level access	Limiting the access of a user by their requirements to carry out their job. An admin will have more rights than a student, for example. Often even admins do not give themselves full rights to prevent accidents, and will instead have a <i>super-user</i> account that will be used only for special high level jobs.
encryption	Encoding all data with a secure private, asymmetric key system, so that if data is stolen, it cannot be read or used.

TYPES OF MALWARE

Virus	A program designed to infect a computer, then copy itself. Requires human 'help' to spread; usually through infected software being installed or spread through unsecure removable media such as usb-drives
Worm	A self-replicating program, which can run itself allowing it to spread very quickly
Trojan Horse	A program which disguises itself as legitimate software, and appears to perform one task, but is actually performing another
Ransomware	Ransomware secretly encodes a users data and files, then offers to un-encode the files if a large amount of money is paid to the hacker
Rootkit	A rootkit allows a hacker to gain full, and often repeated, control of a computer, including the host operating system, which helps the hacker avoid detection

Computing GCSE – 1.6b

J276/01 – System Security – Network Policy

COMMON AREAS OF NETWORK POLICY

Acceptable Use	Governs the general use of the computer system and equipment by employees. Usually limited to that which is required to carry out only the tasks that a user is employed to undertake
Passwords	Rules to ensure that passwords are strong enough to prevent guessing or brute force attack - often requiring the use of upper and lower case letters, numbers and special characters. Also usually a minimum length is required. Passwords usually have to be changed on a regular basis
Email	Governs what may and may not be sent by email
Web Access	The configuration of web browsers may limit the types and categories of website that can be accessed
Mobile Use	What devices are and are not allowed to be used
Remote Access	Govern what can be accessed from outside the system, and what can only be accessed onsite
Wireless	Govern how wireless access points (WAPs) are secured, who has access, and under what circumstances
Software	Governs who can install software, and which users are able to use that software. May have different levels of access once inside the software
Server	Rules about what services are provided by the institution and who may access data stored centrally and for what purposes
Back Up	Back up policy determines how frequently back ups are undertaken, and what type of back up (full, incremental, differential). It will also state where the back up media must be stored and for how long. Often a full weekly back up is required to be stored in a fire proof box in an offsite location
Incident Response Plan	Details what to do if something goes wrong, or if an attack is discovered.

HOW SECURE IS MY PASSWORD?



It would take a computer about
54 MILLISECONDS
 to crack your password

Even modest desktop computers can undertake billions of cycles a second these days. Therefore, without any security features, such as limited password attempts, or asking for only selected characters from a password, a home PC could *brute force crack* commonly used passwords in very, very short periods of time!

PEOPLE ARE ALWAYS THE WEAKEST PART OF A COMPUTER SYSTEM!



Computing GCSE – 1.7a

J276/01 – Operating Systems

KEY VOCABULARY

Operating systems (OS)	Collections of programs that tell the computer hardware what to do.
User interface	The means of communication between the user and the computer. These are typically either <i>command line</i> or <i>GUI</i> .
Command Line	The most simple form of user interface where users type commands into a prompt
Graphic User Interface (GUI)	Most modern computers have a GUI, which uses icons to represent the programs and files. The user runs the programs through a touch-screen or mouse-controlled pointer
Voice Command	Increasingly users are able to speak commands to devices such as Google Home and Amazon's Alexa
Memory management	The OS controls available memory, moving programs to and from secondary storage to RAM
Multitasking	Often users have more than 1 program running at once. In reality, each CPU core can only carryout 1 task at a time, but the OS alternates between the programs to make it appear that multiple tasks are running simultaneously
Peripheral management	Computers must communicate with a range of external devices such as printers, monitors and scanners (peripherals). The OS uses <i>drivers</i> to correctly pass data to the device and ensure correct function.
Drivers	A driver is a piece of software which provides communication between the CPU and a peripherals device
User management	Multiple users can have accounts on the same computer, each with their own files, settings and applications, protected with passwords. The OS will ensure that only users who are granted permissions can use files or programs belonging to other users.
File management	Computers store files and data in hierarchical folder systems. This is efficient and allows for quick navigation

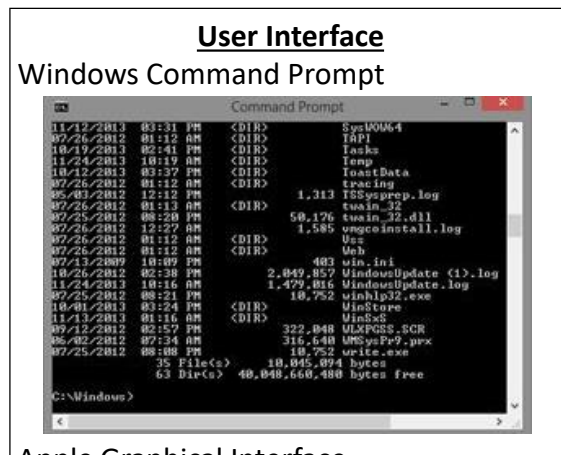
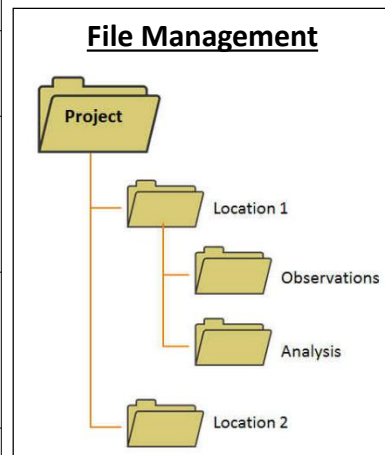
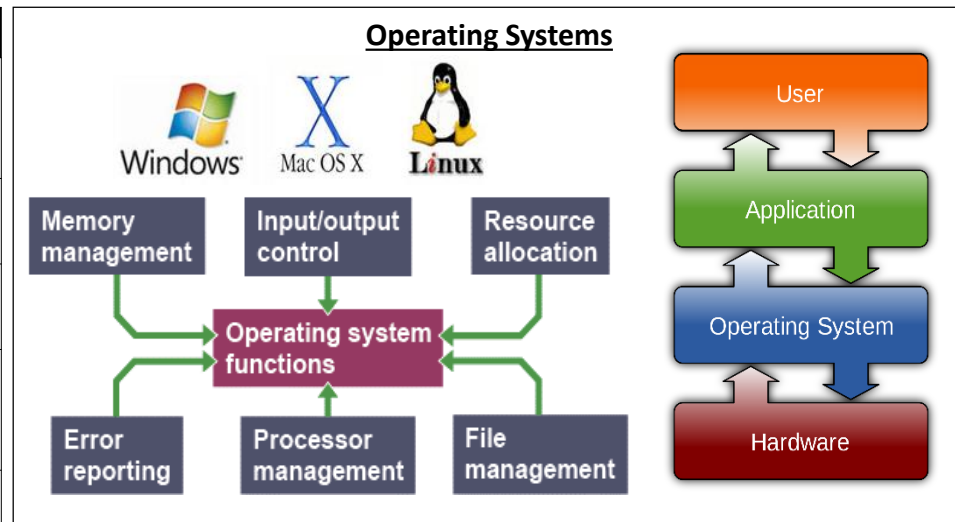

Computing GCSE – 1.7b

J276/01 – Systems Software

KEY VOCABULARY

Utility Software	Utility software supports the OS by performing a limited and specific task. They are used to manage specific actions of the system, or undertake maintenance operations.
Encryption software	In order to keep data secure, especially against outside threats, data must be encrypted. Encryption software uses complex algorithms to encode data so it cannot be read without the private access keys.
Disk Defragmentation	Over time, through multiple updates and saves, files will become split up and distributed over the platters. It takes longer for the files to be accessed, slowing the machine down. Defragmentation reorganises the files' parts to bring them together. See fig 1.
Data Compressions	Allows files to be made smaller by removal of empty space or through compression algorithms (lossy or lossless) – see KO2.6b
Back Up	In case of hardware failure or other computer problems, data should be copied to external media so that it can be restored if lost or damaged.
Antivirus	Continually scans the system to find, quarantine, and clean any file infected with viruses.
Anti-malware	Continually scans to identify any malicious software from being introduced to the system.

TYPES OF BACK UP

	<i>Description</i>	<i>Positives</i>	<i>Negatives</i>
Full	All files and folders are backed up every time	Only requires last back up to restore; quickest to restore	Requires the most space on back up drive; slowest to back up
Incremental	Only new files or files that have been changed since the last back up are copied	Faster to back up; requires less space; does not store duplicate files	Slowest to restore; needs at least one full back up to start

DISK DEFRAGMENTATION:

Over time, as new files get added, old ones deleted and files increase through use, the parts of files get separated around the HDD. (A to B) This separation causes computer slow-down.

In order to improve performance, disk defrag applications shuffle file parts back into order, and moves all free space to the end of the drive.(C)

This improves data access times and overall system performance.

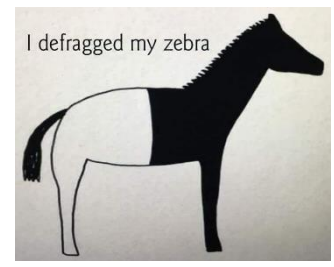
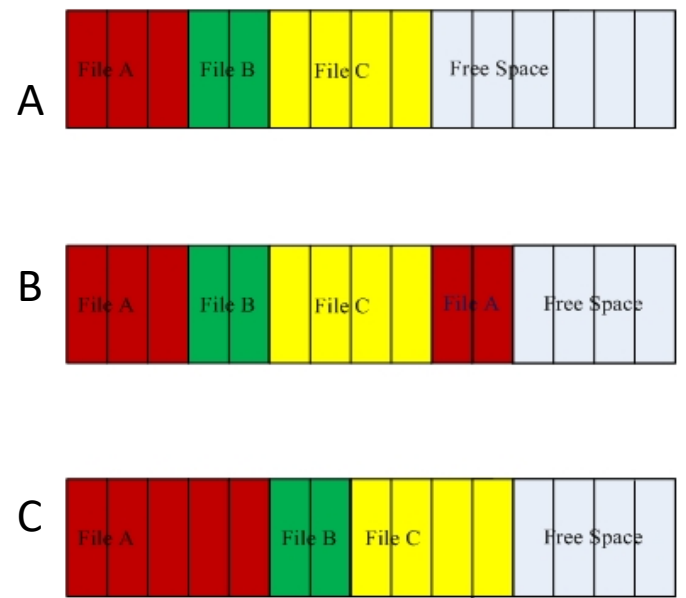

A computing joke... get it?



Computing GCSE – 1.8

J276/01 – Ethical, Legal, Cultural & Environmental

KEY VOCABULARY

Ethical	Relates to <i>right and wrong</i> but in a moral sense than a legal issue. For example, there is nothing to stop you legally from using Facebook to stalk an ex-partner, but whether it is <i>right</i> to do so, is an ethical issue
Legal	There are certain laws set by government that control how computers can be used – see box
Cultural	These issues relate to society and how technology can affect religious, or social ideas. If people spend all their time on their phones rather than talking face to face, this is a cultural issue
Environmental	How computing impacts on the global and local environments. This might be waste production, or mining to gather resources needed to make phones, or using renewable energy to charge phones, or recycling projects. Companies want to be seen to be 'green'.
Privacy	Privacy is a very important issue. A persons right to privacy is very important and there are strong law, alongside ethical guidance that govern how companies can use our data
Stakeholder	Anyone that is impacted on, in any way, by a technology. They have a vested interest
Open source	Software that is created and shared with the source-code able to be seen. Users are free to make alterations to the source-code to meet their own needs, or to improve the system for everyone
Proprietary	Software that is created but the source code is locked. This is often sold and the company wants to protect its intellectual copyright
Legislation	Laws that relate to a certain area

COMPUTING LEGISLATION

The Data Protection Act (1998)	Sets out how data users who store data about individuals must use that data. It is a set of 8 principles which say how personal data must be collected, used and destroyed. See back of sheet
Computer Misuse Act (1990)	Introduced to deal with the increase in computer hacking in the late 1980s when home PCs started to become popular. It aims to protect computer users against willful attacks and theft of information. The Act makes it illegal to: <ul style="list-style-type: none"> • gain unauthorized access to another person's data • ...with the intention of breaking the law further •to delete, alter or sabotage by introducing viruses
Copyright and Design Patents Act (1988)	Provides the creators of intellectual property (ideas = IP) with proof of ownership, and the exclusive rights to use that idea, and distribute their work. It makes it illegal to copy, modify or distribute IP without permission
Freedom of Information Act (2000)	FOI requires public organisations to publish certain data so the public can access it. It also give individuals the right to request to see all data from over 100,000 public bodies. The act covers all electronic information, such as word docs, emails, digital records. Organisations can withhold certain information if releasing it would affect national security
Creative Commons Licensing	Creative Commons Licensing (CC) is a way that copyright holders can grant certain privileges to publicly use, share, adapt, alter and redistribute IP without written permission.

OPEN SOURCE vs PROPRIETARY SOFTWARE

Open source software is freely available so others can use it. Users can access and modify the source-code and create their own versions.	Proprietary software is not freely available. The compiled code is secured and user must use the software as provided. Any attempt to modify, copy or redistribute the software is a breach of Copyright.
EXAMPLES: Linux, Firefox, Android OS	EXAMPLES: Microsoft Office, Adobe Photoshop, OSX

Data Protection Act (1998)

What are the eight principles of it?

1. Data must be kept secure;
2. Data stored must be relevant;
3. Data stored must be kept no longer than necessary;
4. Data stored must be kept accurate and up-to-date;
5. Data must be obtained and processed lawfully;
6. Data must be processed within the data subject rights;
7. Data must be obtained and specified for lawful purposes;
8. Data must not be transferred to countries without adequate data protection laws.

TYPES OF HACKER



Black Hat – The Bad Guys. They break into systems to cause chaos and steal data for their own benefits

White Hat – Penetration Testing professionals. Often employed by companies to test systems and provide feedback on security

Grey Hat – Not trying to cause damage, but aren't trying to help either.

Red Hat – Scary people – stop Black Hat hackers by revenge hacking and destroying the hacker's system

Green Hat – n00bz trying to learn hacking. Often just download scripts from the internet and run them without understanding the code. Often exploited by Black Hat hackers to do stupid things



Attribution

Others can copy, distribute, display, perform and remix your work if they credit your name as requested by you



No Derivative Works

Others can only copy, distribute, display or perform verbatim copies of your work



Share Alike

Others can distribute your work only under a license identical to the one you have chosen for your work



Non-Commercial

Others can copy, distribute, display, perform or remix your work but for non-commercial purposes only.

Computing GCSE – 2.1a

J276/02 – Algorithms: Searching and Sorting

KEY VOCABULARY

Algorithm	An abstracted program which completes a given task, whatever the data provided
Search	Searching is looking through data, making comparisons with a search term, until the algorithm either finds the data, or identifies that it is not present.
Sort	Putting given sets of data into specified order – usually ascending (alphabetical) or descending (reverse alphabetical)
Linear Search	A type of search where the computer checks every variable, in order, until it finds the search term. Potentially very slow.
Binary Search	A search type based on repeatedly halving the searchable data, until the search term is found
Bubble Sort	A method of sorting data which looks at pairs of variable, and swaps them around if out of order. This continues until there are no more swaps to be made
Merge Sort	Splits the data into increasingly small segments, until single data points are reached, then reassembles the data structure one item at a time.
Insertion Sort	Checks through the data until finding the first incorrectly places item. The algorithm then checks all the previous places to see where the data fits, before inserting it into this slot.

LINEAR SEARCH



BINARY SEARCH

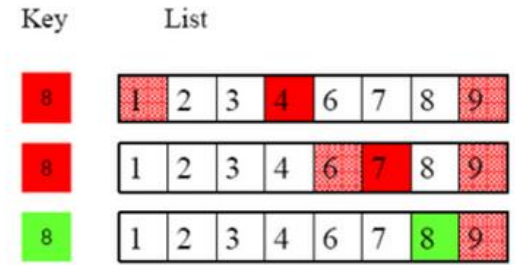

INSERTION SORT

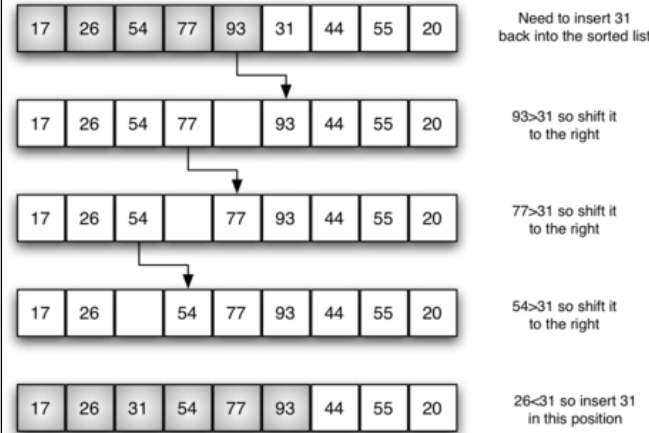

MERGE SORT

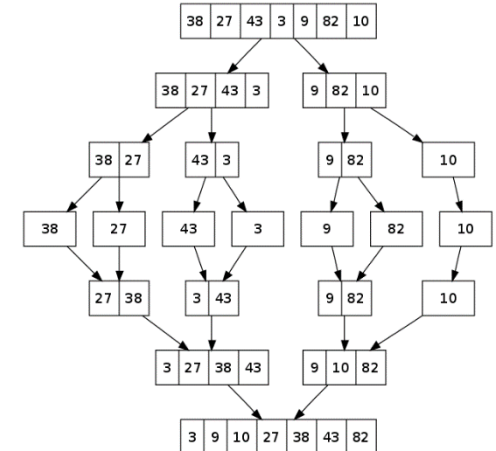

BUBBLE SORT

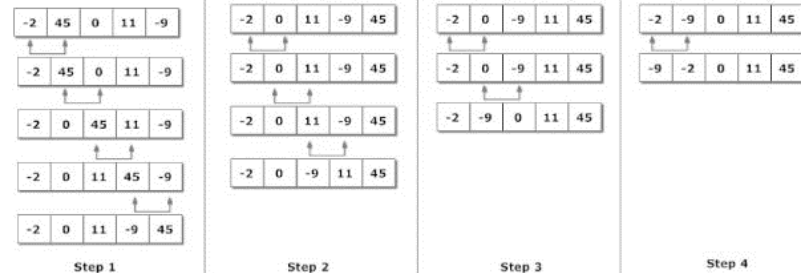

Computing GCSE – 2.1b







J276/02 – Algorithms: Pseudo Code & Flow Charts

KEY VOCABULARY

Algorithm	An abstracted program which completes a given task, whatever the data provided
Abstraction	Abstraction is moving a problem out of the specific in order to create a general solution that would work in similar scenarios. Ignoring the gritty details to focus on the problem
Decomposition	Breaking a problem down into smaller, computational solvable chunks
Pseudo Code	A structured way of planning code, which is 'computational' in style (uses Boolean logic, variables, comparisons and arithmetic for example) but is not tied to a strict high-level language's syntax
Flow Diagram	A diagram, made using specific shaped boxes, that mocks up the flow of a program through various stages, processes and decisions.
Program Control	Using Boolean logic to guide the computer through a program based on decisions
Comparison Operators	The symbols used to look at a variable or piece of data in relation to its similarity to another piece of data or variable
Arithmetic Operators	The symbols used to show the mathematics to be carried out on a piece of data

Flow charts

Flow charts like pseudocode are informal but the most common flow chart shapes are:

	Line	An arrow represents control passing between the connected shapes.
	Process	This shape represents something being performed or done.
	Sub Routine	This shape represents a subroutine call that will relate to a separate, non-linked flow chart
	Input/Output	This shape represents the input or output of something into or out of the flow chart.
	Decision	This shape represents a decision (Yes/No or True/False) that results in two lines representing the different possible outcomes.
	Terminal	This shape represents the "Start" and "End" of the process.

Comparison operators

==	Equal to
!=	Not equal to
<	Less than
<=	Less than or equal to
>	Greater than
>=	Greater than or equal to

Arithmetic operators

+	Addition e.g. $x=6+5$ gives 11
-	Subtraction e.g. $x=6-5$ gives 1
*	Multiplication e.g. $x=12*2$ gives 24
/	Division e.g. $x=12/2$ gives 6
MOD	Modulus e.g. $12\text{MOD}5$ gives 2
DIV	Quotient e.g. $17\text{DIV}5$ gives 3
^	Exponentiation e.g. 3^4 gives 81

Computing GCSE – Python

J276/02 – Programming Techniques

KEY VOCABULARY

Variable	A piece of stored data, used in a computer program, which can be changed or altered by the program
Constant	A piece of stored data which cannot be changed by the program or user
Operator	An operator is a mathematical symbol, used to work with data in a program
Input	Data, entered into a program, by the user
Output	The returned result of an algorithm
Algorithm	A set of instructions to carry out a process or problem-solving operation, especially by a computer
program control	Selection of code to be executed, based on the results of prior operations in a program, or user input
Loop	A piece of repeating code
Iteration	A type of LOOP which repeats a series of steps with a finite number of variable changes
Sentinel	A type of LOOP that watches a variable for a logical (T to F, or F to T) and repeats until that change occurs
Conditional	A method of controlling the information flow through branching steps – the code checks if something is True, then carries out one set of instructions if it is, and a different set of instructions if it is False.
Sequence	A series of coded instructions for a computer to follow, step by step
String	A character, or characters, stored as a list, within “ ”.
Integer	A whole numbers, stored as its value
Real	A decimal number, stored as its value
Boolean	True or False. Stored as 1 or 0.

KEY VOCABULARY

Declaration	Assigning a value to a variable																				
Typecasting	Casting a variable as and integer, Bool, Float or String																				
Data Arrays	<p>‘Lists’ of data, stored in an indexable table format</p> <p><u>1 D ARRAY:</u></p> <table border="1" style="display: inline-table; margin-right: 10px;"> <tr> <td>C</td><td>O</td><td>D</td><td>I</td><td>N</td><td>G</td><td>E</td><td>E</td><td>K</td> </tr> <tr> <td>0</td><td>1</td><td>2</td><td>3</td><td>4</td><td>5</td><td>6</td><td>7</td><td>8</td> </tr> </table> <p>← single row of elements</p>	C	O	D	I	N	G	E	E	K	0	1	2	3	4	5	6	7	8		
C	O	D	I	N	G	E	E	K													
0	1	2	3	4	5	6	7	8													
2D Arrays	<p>A data structure which has more than 1 ‘row’ of data. 2D arrays use 2 indexes to identify data</p> <p>IMPORTANT!!! 2D arrays use the Y axis first in the co-ordinates, then the X axis. This is the opposite way around to most other co-ordinates!</p> <table border="1" style="margin-left: auto; margin-right: auto;"> <thead> <tr> <th></th> <th>Column 1</th> <th>Column 2</th> <th>Column 3</th> <th>Column 4</th> </tr> </thead> <tbody> <tr> <th>Row 1</th> <td>a[0][0]</td> <td>a[0][1]</td> <td>a[0][2]</td> <td>a[0][3]</td> </tr> <tr> <th>Row 2</th> <td>a[1][0]</td> <td>a[1][1]</td> <td>a[1][2]</td> <td>a[1][3]</td> </tr> <tr> <th>Row 3</th> <td>a[2][0]</td> <td>a[2][1]</td> <td>a[2][2]</td> <td>a[2][3]</td> </tr> </tbody> </table>		Column 1	Column 2	Column 3	Column 4	Row 1	a[0][0]	a[0][1]	a[0][2]	a[0][3]	Row 2	a[1][0]	a[1][1]	a[1][2]	a[1][3]	Row 3	a[2][0]	a[2][1]	a[2][2]	a[2][3]
	Column 1	Column 2	Column 3	Column 4																	
Row 1	a[0][0]	a[0][1]	a[0][2]	a[0][3]																	
Row 2	a[1][0]	a[1][1]	a[1][2]	a[1][3]																	
Row 3	a[2][0]	a[2][1]	a[2][2]	a[2][3]																	

Computing GCSE – 2.3

J276/02 – Producing Robust Programs

KEY VOCABULARY

Defensive design	Planning a program from the very beginning to prevent accidental or purposeful misuse
Input sanitization	Removing erroneous data from a system prior to processing
Data validation	Ensuring all data is in the correct format prior to processing
Contingency planning	Having built in checks and outcomes based on what happens when things go wrong
Anticipating misuse	Building programs which do not allow a user to deliberately break the system
Authentication	Having different levels of user, and preventing everyday users from being able to significantly change a system
Maintainability	Building software which is modular to enable sections to be updated and replaced without having to write the whole program again from scratch
Code comments	Annotating code so that the person maintaining or working with your code in the future is able to understand your thought process
Indentation	Making code more readable by laying it out in a manner that keeps sections of code separate
Iterative testing	Step by step testing to ensure that small sections of the code work, before new parts are added and then retested. Important to allow <i>traceback</i> to find what caused any errors
Terminal testing	Significant testing done once a program is complete under a range of conditions and on multiple hardware – often called <i>Alpha Testing</i>
Beta Testing	Making a small release of the software to a group of tech-literate enthusiasts to broaden the usage-testing and get lots of feedback prior to full release.
syntax error	An error in the typing of the code. Missing punctuation, spacing etc
Test data	Data chosen to test the program. Testers use a specific range of data

TESTING DATA

Data Range	The data that will be used to check the code works correctly
Valid Data	Obvious data which should definitely pass
Valid Extreme	Unusual data – the highest and lowest data – on the very edge of what should pass
Invalid Extreme	Data, of correct type, which is on the very edge of what should fail
Invalid Data	Data, of the correct type, that should definitely fail
Erroneous Data	Data that is the wrong type and should fail
Expected Outcome	The data the code should output if it is running correctly

ERROR TYPES

Syntax Error	An error in the code – incorrectly typed, missing punctuation etc
Logical Error	An error which, although allows the code to run, produces incorrect outcomes
EOF Error	The <i>End of File</i> has been reached, whilst the computer is waiting for a snippet to be completed.
Type Error	Attempting to use data incorrectly – adding 1 to a string etc
Name Error	Using a variable before its declaration
Indentation Error	Loops or functions are incorrectly indented

Models of Software Development

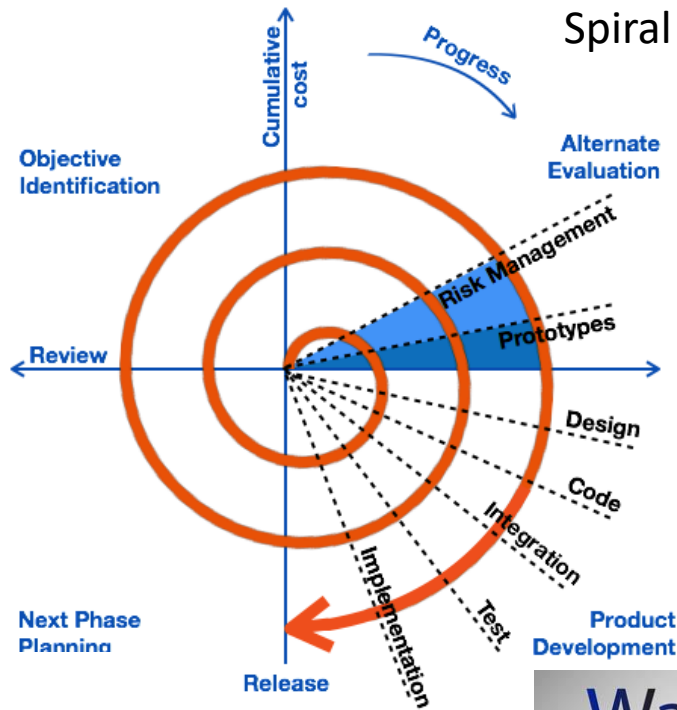

Spiral Development

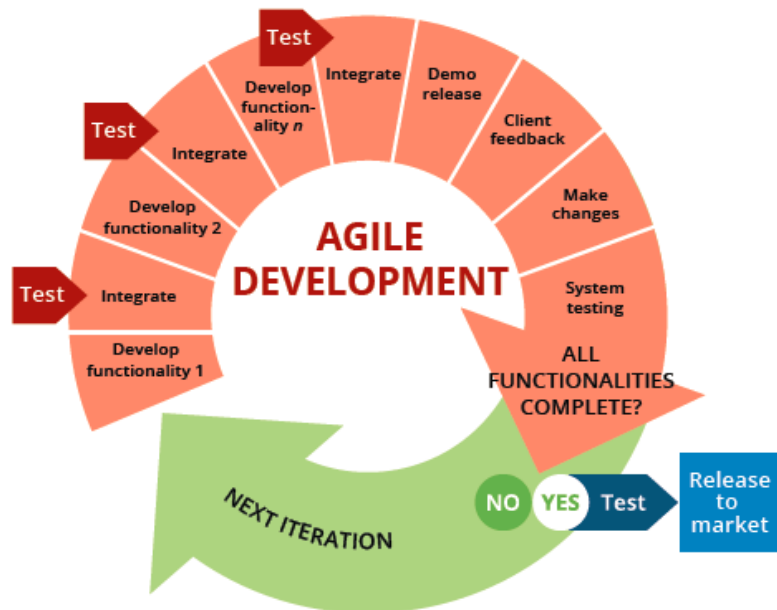

Waterfall-Model

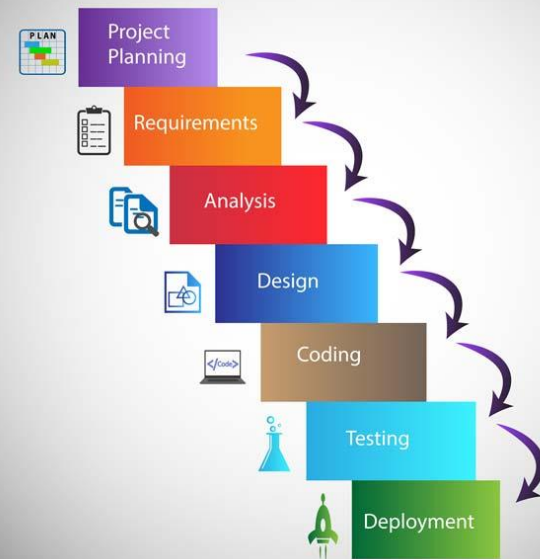

Computing GCSE – 2.4

J276/02 – Computational Logic

KEY VOCABULARY

Logic	A system designed to perform a specific task according to strict principles.
Logic Gates	The physical switches inside an electronic device which are able to perform the calculations a computer needs to carry out on electronic signals
Truth Table	A tabular representation of the possible inputs and outputs from a given logic gate, or collection of gates
Boolean	Mathematical <i>TRUE</i> or <i>FALSE</i>
Operator	A mathematical symbol in computing
+	Addition [1+2=3]
-	Subtraction [2-1=1]
/	Division [5 / 2=2.5]
*	Multiplication [2 * 2 = 4]
^	Exponentiation, raising a number to the power of... [3^3 = 3 * 3 * 3 = 27]
MOD	Modulus division. To divide a number by another, but only return the <i>remainder</i> [10 MOD 3 = 1]
DIV	Integer Division. To divide a number by another, but only return the <i>number of full sets</i> . [10 DIV 3 = 3]

LOGIC GATES

These gates take inputs (usually labelled A, B, C etc, and provide a single output. In this case labelled F, but could be another letter. Each gate is shown with its TRUTH TABLE

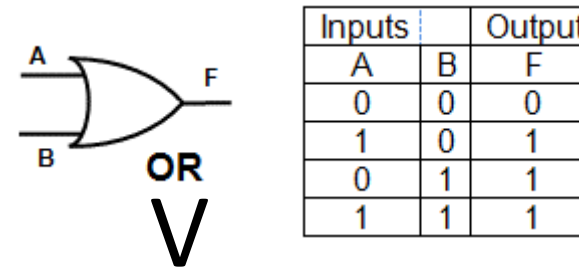
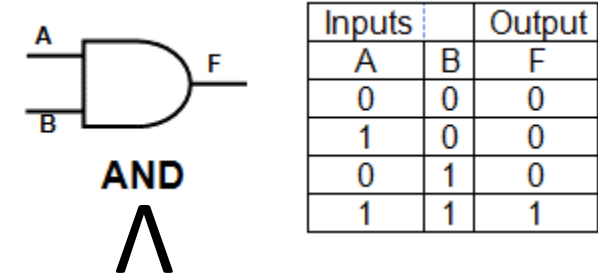
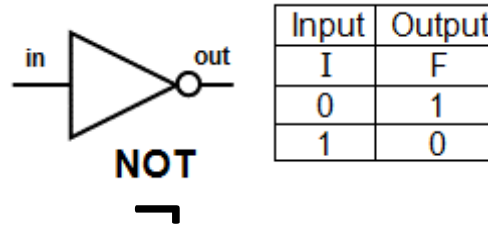

COMBINED GATES – Logic gates can be combined in any order to provide a range of computational possibilities. Inside a CPU, the physical switches are logic gates, and but combining them in different sequences, computers can undertake incredibly complex mathematics with these very simple tools.

$$\underline{(\text{NOT } A) \text{ OR } (B \text{ AND } C)}$$

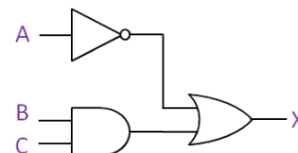

A	B	C	NOT A	B AND C	X = (NOT A) OR (B AND C)
0	0	0	1	0	1
0	0	1	1	0	1
0	1	0	1	0	1
0	1	1	1	1	1
1	0	0	0	0	0
1	0	1	0	0	0
1	1	0	0	0	0
1	1	1	0	1	1

Computing GCSE – 2.5

J276/02 – Translators and Facilities of Languages

KEY VOCABULARY

Low Level Language	A programming language which is closer to binary than English
High Level Language	An abstracted programming language which is closer to English than binary
Instruction Set	Binary code which tells the computer hardware what to do – OpCode and Operand
Machine Code	1 to 1 instructions coded in mnemonics (STO, ADD, MOD, DIV etc) which must be converted to binary to run
Abstraction	Removing a level of detail to allow focus on the problem solving rather than the specifics. <i>Python, and all other High Level languages are abstracted. You do not need to know the machine code to get something to happen</i>
Translator	A utility to convert High Level Code into binary machine code so it can be executed
Interpreter	A utility which translates High Level code on a line by line basis and executes the program as it goes in a special test environment
IDE	Integrated Development Environment
Text Editor	A place to type code, focused on the content of the file, not the look of the file
Error Diagnostics	To test a program and provide feedback to the coder so that errors can be fixed
Run Time Environment	Part of an IDE which allows a piece of code to be tested without installation

Working the Machine:

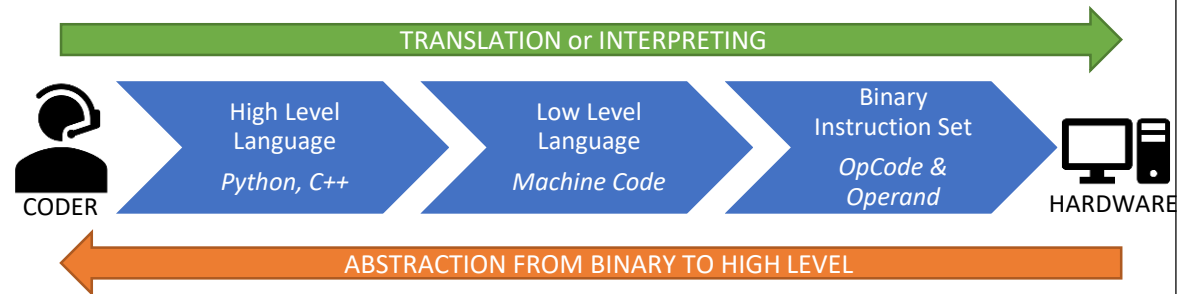

For coders to be able to write code quickly, high-level coding language have been made which allow the coder to use *almost* natural language (like English) to solve problems. These **ABSTRACTED LANGAUGES** must be converted into binary code instructions that the CPU can execute in order to work. This conversion of instructions is done in 1 of 2 ways. They are either *interpreted*, one line at a time, and executed immediately, or they are *translated* by converting the entire code file in one go, then attempting to run the program only once the converter has finished *compiling*. c

Features of an Integrated Development Environment (IDE)

FEATURE	PURPOSE and BENEFITS
Text Editor	An IDE's text editor is where the code is typed. It is not concerned with the look of the code, but usability. Additional features of IDE text editors are: line numbers, code colouring by context, automatic indentation, autocomplete, code-folding, overview 'map', multiple cursors
Error Diagnostics	IDEs will give real-time feedback to the coder to show any obvious errors before compiling. These are often with highlighting or line markers. Additionally, any errors which show up during compiling are flagged with helpful guidance to the coder about the error type and the line number
Compiler	A utility which attempts to turn the program into a runnable program. This will either be a translator/compiler or an interpreter
Run-Time Environment	A 'safe sandbox' where code can be tried out without installing it to the computer. Often ring-fenced from the main machine to prevent accidents.

Computing GCSE – 2.6a

J276/02 – Data Representation 1

REMEMBER MAXIMUM VALUES!

Max value which can be represented with 8 bits (1 byte) = **255**

Total number of available values = **256 (255 + 0)**

KEY VOCABULARY

Denary	Base 10 number system. Uses digits 0,1,2,3,4,5,6,7,8,9
Binary	Base 2 number system. Uses digits 0 and 1 only.
Hexadecimal (Hex)	Base 16 number system. Uses characters 0-9 and A,B,C,D,E and F
BIT	Contraction of BINARY DIGIT – a single value of 0 or 1
Binary Code	Representation of values using multiple bits
Character Set	A list of unique values, stored in binary, which represent the letters, numbers and symbols a computer can show/use.
ASCII	American Standard Code for Information Interchange. A character set which uses 7 bits to store 128 (2^7) characters
Extended ASCII	A character set which uses 8 bits to store 256 (2^8) characters
UNICODE	A characters set which uses 16 bits to store 65,535 characters (2^{16})
INTEGER	A whole number (value written to 0 decimal places)
FLOAT	A decimal value
Conversion	Moving a value from one data type/representation to another, for example Binary to Hex
Exponent	Mathematical term which tells you how many time to multiply a BASE by itself.

UNITS OF DATA IN COMPUTER SYSTEMS

UNIT	VALUE	SIZE
bit (b)	0 or 1	1/8 of a byte
nibble	4 bits	½ a byte (a nibble... get it?!)
byte (B)	8 bits	1 byte
kilobyte (kB)	1000^1 bytes	1,000 bytes
megabyte (mB)	1000^2 bytes	1,000,000 bytes
gigabyte (gB)	1000^3 bytes	1,000,000,000 bytes
terabyte (tB)	1000^4 bytes	1,000,000,000,000 bytes
petabyte (pB)	1000^5 bytes	1,000,000,000,000,000 bytes

BINARY PLACE VALUES

BASE Exponent	2^7	2^6	2^5	2^4	2^3	2^2	2^1	2^0
PLACE VALUE	128	64	32	16	8	4	2	1

CONVERTING DENARY TO BINARY TO HEX

HEXADECIMAL	
DENARY	HEX
0-9	0-9
10	A
11	B
12	C
13	D
14	E
15	F

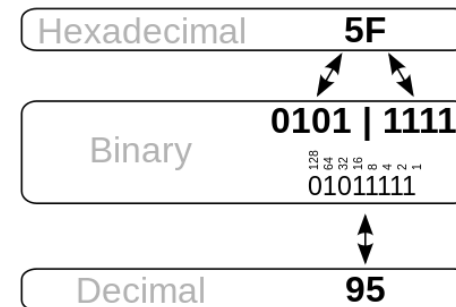

There are two methods for converting a HEX value to Denary

OR:
 $5F = (5 \times 16) + F$
 $5F = 80 + 15$
 $5F = 95$

Computing GCSE – 2.6b

J276/02 – Data Representation 2

KEY VOCABULARY

Overflow Error	Where the denary value cannot be represented with the given number of bits.
Binary Shift	The method for multiplying and dividing numbers in binary. Is not necessarily mathematically correct
Most Significant Bit	The left-most bit in a binary number – it has the highest value
Least Significant Bit	The right-most bit in a binary number – it has the lowest possible value = 0 or 1
Check Digits	Bits used to ensure that the value sent digitally is not corrupted on transfer
Lossy Compression	Data is removed from the file to make it smaller. This data is lost and cannot be regained. Suitable where the loss of data is likely not to be noticed. Eg images
Lossless Compression	No data is lost, but rather rearranged to ensure a perfect version of the data can be returned. Used where exact reproduction is vital. Eg text documents
JPEG / JPG	Joint Photographic Experts Group Compression for images – lossy
GIF	Graphics Interchange Format Lossless bitmapped image format for limited colours.
PDF	Printable Document Format Open standard for reproducing text and graphic documents without editing permissions – lossless
MPEG	Moving Pictures Expert Group Audio-Visual encoding for video Lossy
MP3	Moving Pictures Expert Group Audio Layer 3 Digital music files. Lossy compression, but very good and generally only removes sounds that are beyond human hearing range

BINARY ADDITION

$$\begin{array}{cccc}
 0 & 1 & 0 & 1 \\
 +0 & +0 & +1 & +1 \\
 \hline
 00 & 01 & 01 & 10 \\
 & & & \uparrow \\
 & & & \text{carried bit}
 \end{array}$$

When adding 2 large binary numbers, if there is not enough bits to take the *carried bit* then this results in an **OVERFLOW ERROR**

$$\begin{array}{cccccccc}
 1 & 1 & 0 & 0 & 1 & 1 & 0 & 1 \\
 + & 0 & 1 & 0 & 1 & 1 & 1 & 0 \\
 \hline
 1 & 0 & 0 & 1 & 0 & 1 & 0 & 1
 \end{array}$$

This value is not counted, it is *overflow*.

In 8 bits, this sum reads : 203 + 94 = 43!

BINARY SHIFT

Multiplication	Binary shift to the LEFT
Division	Binary shift to the RIGHT

By *moving the bits* to either the left of the right, we can double (x2) or halve (%2) the value with each movement.

$$\begin{array}{cccc}
 8 & 4 & 2 & 1 \\
 1 & 0 & 1 & 1 & =11
 \end{array}$$

A 1 place RIGHT SHIFT (divide by 2)

$$\begin{array}{cccc}
 8 & 4 & 2 & 1 \\
 0 & 1 & 0 & 1 & =5
 \end{array}$$

The bits which are moved outside of the available value places are **LOST**. They cannot be returned by reversing the shift. The same is true at the highest place value

$$\begin{array}{cccc}
 8 & 4 & 2 & 1 \\
 1 & 0 & 1 & 1 & =11
 \end{array}$$

A single LEFT SHIFT (multiply by 2) would result in an overflow error (when represented with 4 bits.)

$$\begin{array}{cccc}
 8 & 4 & 2 & 1 \\
 1 & 0 & 1 & 1 & =10
 \end{array}$$

Computing GCSE – 2.6c

J276/02 – Data Representation 3

KEY VOCABULARY

Pixel	Smallest element of an image – the dots that make up an image on a screen
Bitmap	An image where every pixel is 'mapped' in binary to show its colour, transparency (Alpha) and brightness (Gamma) Increasing size will lower the quality
Vector	An image where the lines are stored as mathematical shapes, so the size can be increased without impacting quality
RGB	Red Green Blue – the order of colour data in a pixel
Colour Depth (bit depth)	The number of bits used to represent each pixel. Shown in bits per pixel (bpp)
Resolution	The number of pixels used per unit eg pixels per inch (ppi)
Metadata	Data about the data – in relation to images, it is the data that allows the computer to recreate the image from its binary form.
Analogue	Continuous changing values – no “smallest interval”
Bit Depth	The number of bits used to store the sound
Bit Rate	The number of bits used to store 1 second of sound
Sample Rate	The number of times the sound is sampled in 1 second; measured in kHz (kilohertz or 1000's per second)

SOUND SAMPLING

Measurement of amplitude ↑ Sound wave

1111
1110
1101
1100
1011
1010
1001
1000
0111
0110
0101
0100
0011
0010
0001
0000

Time

Each measurement is assigned a number (byte) according to its amplitude. The end result is a file comprising a string of bytes, eg ... 1001 1110 0001 1010 0111 0100 1111 1101 etc

File Size

Sample Frequency

Sound Quality

As the sample rate increases, the quality of the sound goes up – the sound is closer to the analogue original, but the file size also increases. Reduce the sample rate, you reduce quality but also file size.

BIT DEPTH = NUMBER OF COLOURS

Bit depth	Available colours
1 bit (Monochrome)	$2^1 = 2$
2 bits	$2^2 = 4$
3 bits	$2^3 = 8$
8 bits	$2^8 = 256$
16 bits (High Color)	$2^{16} = 65,536$
24 bits (True Color)	$2^{24} = 16.7$ million
32 bits (Deep Color)	$2^{32} = 4.3$ billion

ESTIMATING FILE SIZES

IMAGES:

$$\text{width} \times \text{height} \times \text{colour depth} = \text{size}$$

SOUND:

$$\text{N}^\circ \text{ of channels} \times \text{sample rate} \times \text{bit depth}$$

To get the value into mB, you divide by
1,000,000!