

MACHINES /EQUIPMENT FOR NATURAL WOODS AND BOARDS

WORLD ASSOCIATION OF TECHNOLOGY TEACHERS <https://www.facebook.com/groups/254963448192823/> www.technologystudent.com © 2018 V.Ryan © 2018

INSTRUCTIONS

FOR EACH OF THE MACHINES SHOWN ON THIS SHEET, FIND INFORMATION ON HOW THEY ARE USED. THEN, CREATE AN INFORMATION SHEET FOR EACH ONE, WHICH SHOULD INCLUDE SKETCHES AND NOTES.

YOU WILL FIND ALL THE INFORMATION YOU NEED IN - THE 'EQUIPMENT AND PROCESSES SECTION' AND/OR THE 'POWER TOOLS SECTION' OF: www.technologystudent.com

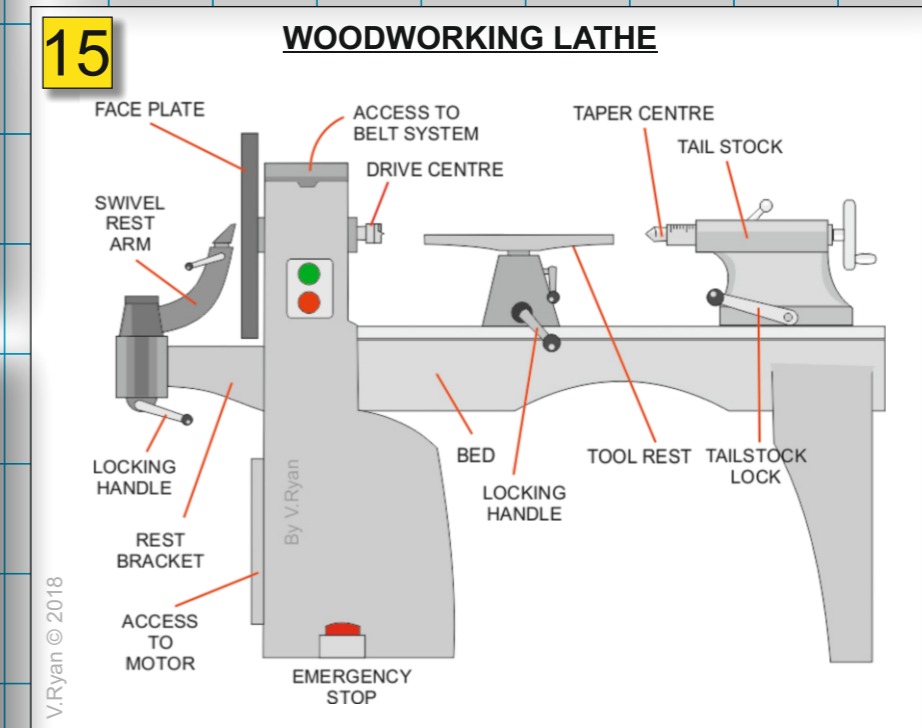
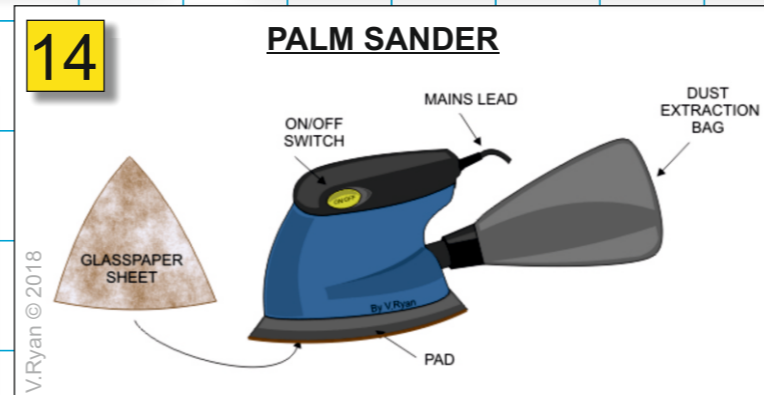
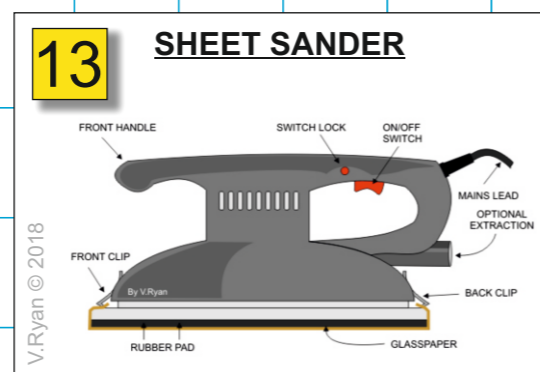
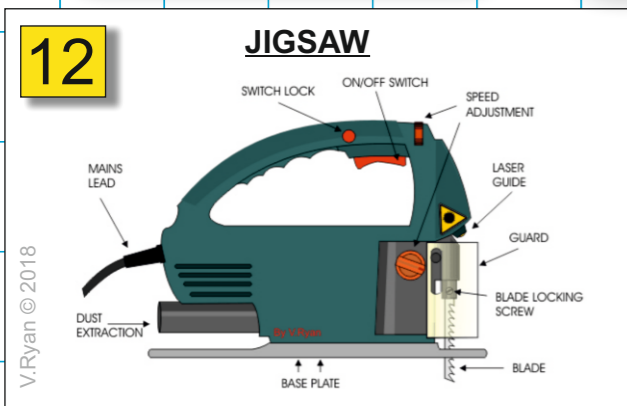
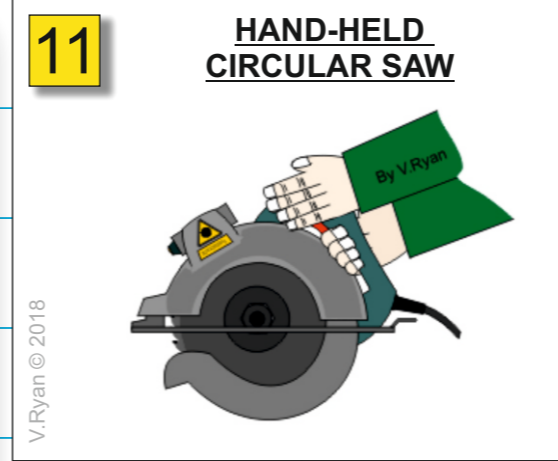
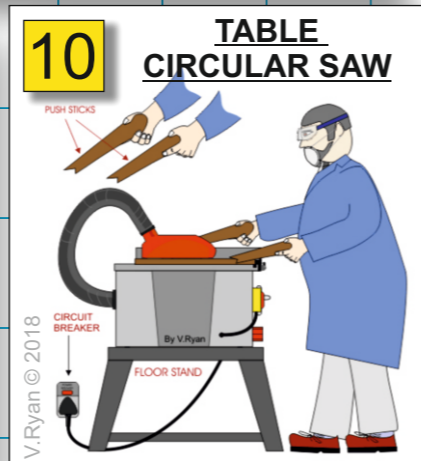
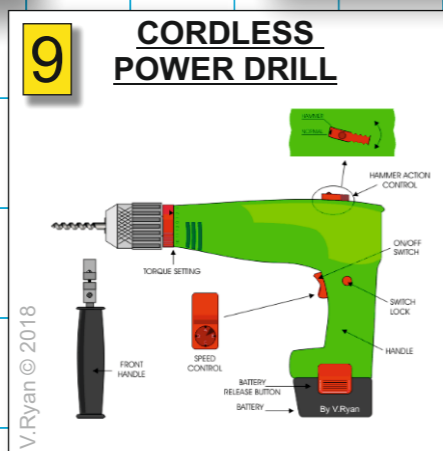
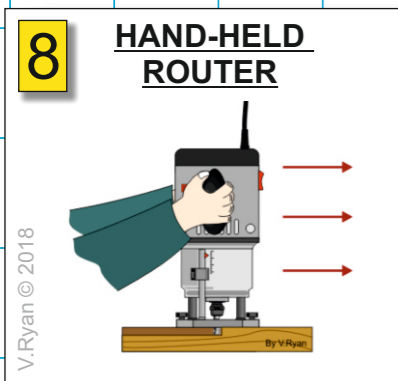
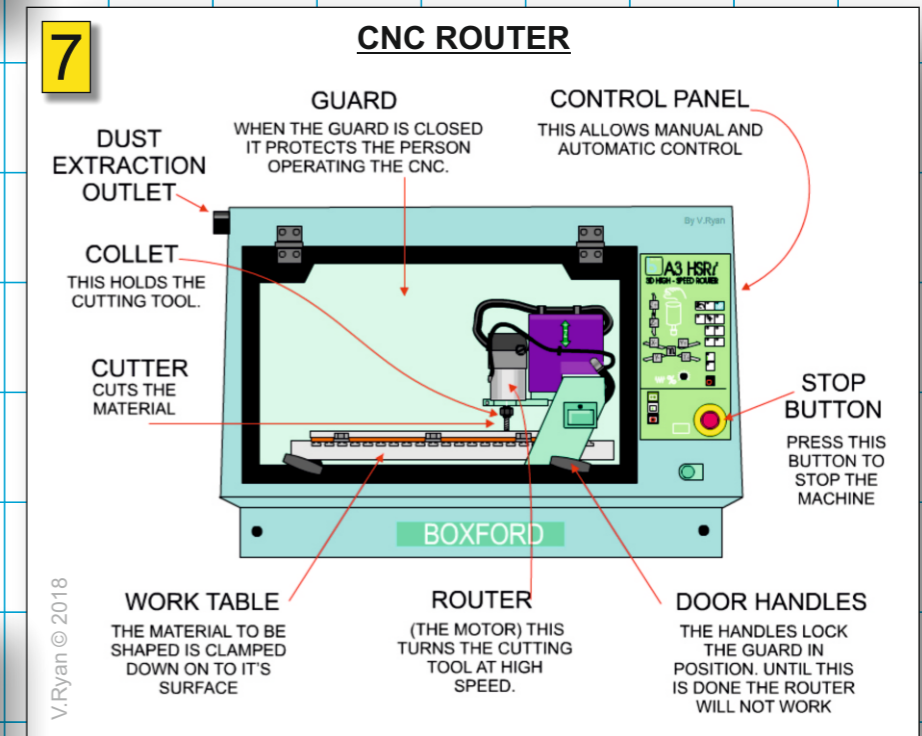
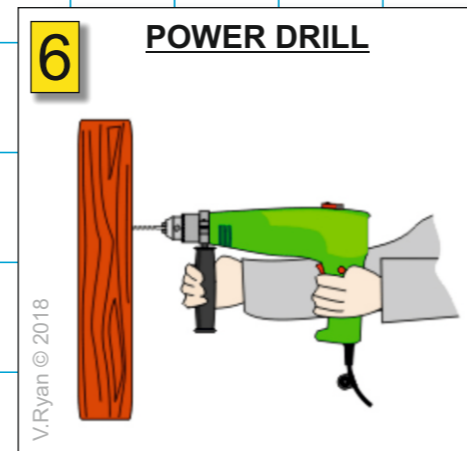
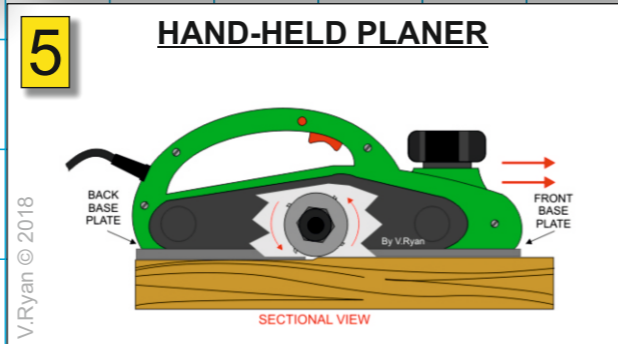
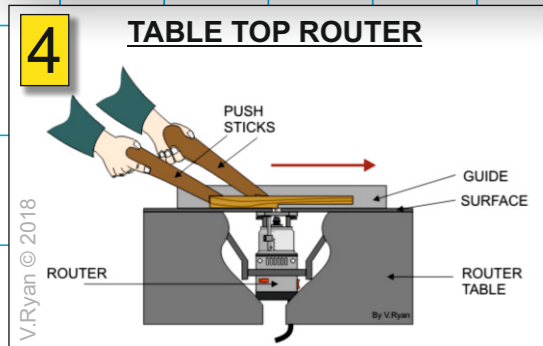
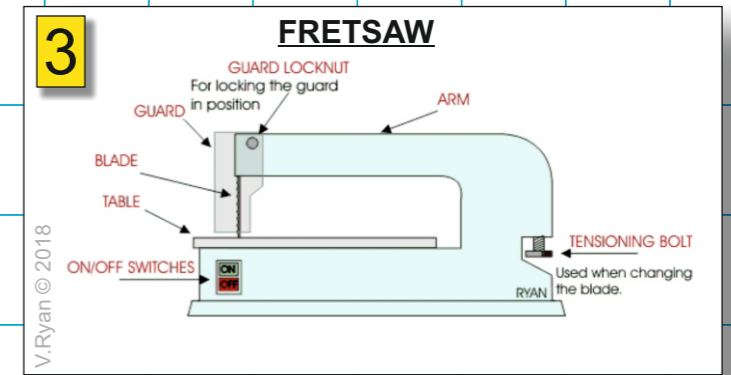
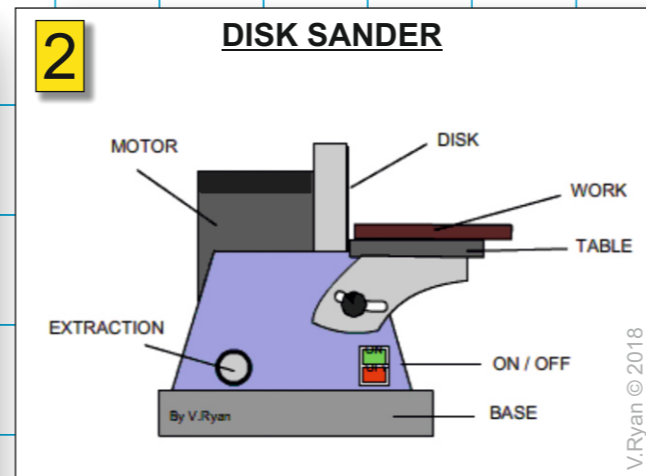
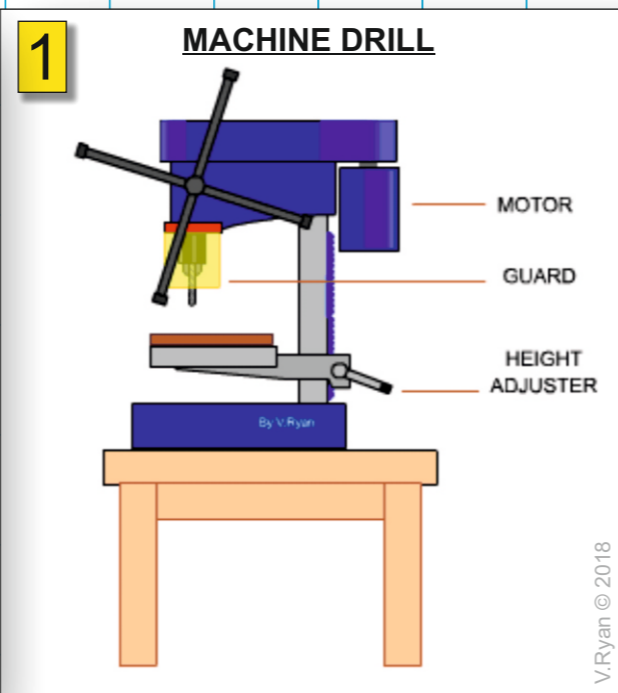

WORLD ASSOCIATION OF TECHNOLOGY TEACHERS <https://www.facebook.com/groups/254963448192823/> www.technologystudent.com © 2018 V.Ryan © 2018

WORLD ASSOCIATION OF TECHNOLOGY TEACHERS <https://www.facebook.com/groups/254963448192823/> www.technologystudent.com © 2018 V.Ryan © 2018